

Öztiryakiler

SAVUNMA EKİPMANLARI SAN. TİC. A.Ş.



2021

SAHRA YAŞAM ÜNİTELERİ
MOBILE FIELD LIVING UNITS

- 03**
04 KONTEYNERLERİN ORTAK ÖZELLİKLERİ
COMMON FEATURES OF CONTAINERS
- 05**
08 SEYYAR SAHRA MUTFAK ÜNİTESİ
FIELD KITCHEN UNIT
- 09**
12 SEYYAR SAHRA FIRIN ÜNİTESİ
FIELD BAKERY UNIT
- 13**
16 SEYYAR SAHRA BANYO ÜNİTESİ
FIELD SHOWER UNIT
- 17**
20 SEYYAR HELA VE EL-YÜZ YIKAMA ÜNİTESİ
TOILET AND SANITARY UNIT
- 21**
24 SEYYAR SAHRA ÇAMAŞIR YIKAMA ÜNİTESİ
FIELD LAUNDRY UNIT
- 25**
28 SEYYAR SAHRA BULAŞIK YIKAMA ÜNİTESİ
FIELD DISH WASHING UNIT
- 29**
32 SEYYAR SU ARITMA VE DEPOLAMA ÜNİTESİ
WATER PURIFICATION AND STORAGE UNIT
- 33**
34 SEYYAR SAHRA SOĞUK HAVA ÜNİTESİ
FIELD COLD ROOM UNIT
- 35**
36 SEYYAR ÇAMAŞIR DEPOLAMA ÜNİTESİ
LAUNDRY STORAGE UNIT
- 37**
38 SEYYAR SAHRA UN DEPOLAMA ÜNİTESİ
FIELD FLOUR STORAGE UNIT
- 39**
40 SEYYAR SAHRA ERZAK DEPOLAMA ÜNİTESİ
FIELD FOOD STORAGE UNIT



“

Harbi ilk önce lojistik ile kazanırsınız sonra ordular gider ve zaferi gerçekleştirir.

You win the war first by logistics then the armies go and realize the victory.

Vous gagnez la guerre d'abord par la logistique, puis les armées s'y rendent et concrétisent la victoire.

”



TR

20 feet ISO çelik konteynerler kara, hava, deniz vasıtalarıyla ve ulusal/uluslararası taşıma araçlarıyla taşınabilir altyapıya sahiptir ve CSC sertifikalıdır. Konteynerde 4 adet kaldırma ve dengeleme ayağı mevcuttur. Dengeleme ayakları arazi anızalarına göre en fazla 300 mm.'ye kadar ayarlanabilir (yükselebilir/alçaltılabilir) özelliğindedir ve zemine batmaması amacıyla 300x300 mm. ebadında taban levhaları mevcuttur. DROPS araçları ile taşınabilir niteliktedir. Konteyner dört köşe noktasından mapalar yardımıyla halat/ kilit tertibatı geçirilerek de taşımaya elverişlidir. Konteyner, en az -35°C ile +60°C sıcaklık aralığındaki ortamlarda kullanılabilir.

➤Konteyner dış duvarında, tavana ve taban şasesinde uygun izolasyon malzemesi kullanılmaktadır.

EN

20 feet ISO steel containers are transportable by land, sea or air and national / international transport vehicles and CSC certified. There are 4 lifting and leveling feet on the container. Leveling feet can be adjusted up to 300 mm (raised / lowered) according to the land surface and 300x300 mm by the base plates in order not to sink into the ground. It is transportable by DROPS. The container is also suitable for transportation by passing rope / lock device with the help of eyebolts at four corners. The container can be used in environments with a temperature range of -35°C to +60°C. Suitable insulation material is used on the outer wall of the container, on the ceiling and on the base chassis. The outer surface of the base is covered by spraying method, against

FR

Les conteneurs en acier ISO 20 pieds disposent d'une infrastructure pour le transport par voie terrestre, maritime ou aérienne et par véhicules de transport nationaux / internationaux et sont certifiés CSC. Il y a 4 pieds de levage et de nivellement dans le conteneur. Les pieds de nivellement peuvent être ajustés jusqu'à 300 mm (relevé/abaissé) selon la surface du terrain et sont pourvus de plaques 300x300 mm à leur base afin de ne pas s'enfoncer dans le sol. Ils sont transportables par DROPS. Le conteneur est également adapté au transport par un dispositif de cordes verrouillées à l'aide de boulons à œil dans ses quatre coins. Le conteneur peut être utilisé dans des environnements avec une plage de température allant de -35°C à +60°C. Un matériau isolant approprié est utilisé sur les parois extérieures, au plafond et sur le châssis de base du conteneur. La surface extérieure

- Taban dış yüzeyi, sızdırmazlık ve dış etkenlerden koruma amacıyla, bakteri ve haşere barındırmayan, koku yapmayan malzeme ile püskürtme yöntemi ile kaplanmıştır.
- Dış kapılar, sadece dışarıdan kilitlenebilmektedir ve kilitletisi olsa dahi içeriden acil çıkış kapı kolu (Panik Bar) ile açılabilir.
- Dış kapılara rüzgardan örtülmesini veya çarpmasını engellemek üzere kapı sabitleyici kanca kullanılmaktadır.
- Dış kapıların önüne hareketli, ayarlanabilir, merdiven basamakları konulmaktadır.
- Priz ve anahtarlar, sıva üstü kasalara monte edilmiştir.
- Topraklama ve yıldırım koruma sistemi vardır.
- Şebeke veya jeneratörden beslenebilir.

bacteria, insects, smell and for the purpose of sealing and protection from external factors. The outer doors can only be locked from the outside, and even if locked, the emergency exit from the inside can be opened with the door handle (Panic Bar). Door stabilizer hooks are used to prevent the external doors from being closed by the wind or crashing. Movable, adjustable, stair steps are placed in front of the outer doors. Switches are mounted on surface-mounted cases. It has grounding and lightning protection system. It can be fed from the city system or generator.

de la base est recouverte par pulvérisation d'un produit qui ne contient pas de bactéries, ni d'insectes, sans odeurs, dans le but de permettre l'étanchéité et la protection contre les facteurs externes. Les portes extérieures ne peuvent être verrouillées que de l'extérieur, et même verrouillées, elles peuvent être ouvertes de l'intérieur à l'aide d'une poignée de secours (Panic Bar). Des crochets stabilisateurs de porte sont utilisés pour empêcher les portes extérieures de se refermer avec le vent ou de se heurter. Des marches d'escalier mobiles et réglables sont placés devant les portes extérieures. Les prises et interrupteurs sont montés dans des boîtiers en saillie. Ils disposent d'un système de mise à terre et de protection contre la foudre. Ils peuvent être alimentés par courant de secteur ou par générateur.





TR

Mutfak 500 kişinin yemek ihtiyacını karşılayacak şekilde tasarlanmıştır. Konteyner; elle çalıştırılabilir mekanik sistemle içerisinde ekipmanlar kurulu iken genişleyebilir (üç açılır) özelliğe sahiptir. Taşınacağı zaman genişleyebilir sistem kapatılarak ISO ölçülerine getirilerek sevk edilebilir. Konteyner içerisinde konvansiyonel fırın, fırın arabası, pişirme kazanı, fritöz, induksiyon ocağı, kıyma makinesi, mikser, sebze doğrama makinesi, patates soyma makinesi, bıçak sterilizasyon cihazı, çalışma tezgahı, davlumbaz, evye, çöp arabası, doğrama tablası ve el aletleri (bıçak, kevgir, kepçe vb.) mevcuttur. Dizel yakıtla çalışır.

- ▷ Taban döşemesi üzeri, sızdırmaz olacak şekilde en az 2/3 (iki taksim üç) mm kalınlığında çetali alüminyum yer kaplaması ile kaplanmıştır.
- ▷ Taban döşeme altına membranla su yalıtımı sağlanmıştır.

EN

The kitchen is designed to meet the food needs of 500 soldiers. It has an expandable (three opens) feature with the manual operated mechanical system while the equipment is installed. When the container is to be transported, the expandable system can be closed to ISO measurements and shipped. There are conventional oven, oven trolley, cooking vessel, fryer, induction stove, meat grinder, mixer, vegetable chopping machine, potato peeler, knife sterilization device, workbench, hood, sink, garbage bin, chopping tray and hand tools (knife, skimmers, scoops, etc.) in the container.

- ▷ The floor is covered with a aluminum floor covering with a thick ness of 2/3 (two parts three) mm.
- ▷ Under the floor covering, membrane waterproofing is provided.

FR

La cuisine est conçue pour répondre aux besoins en nourriture de 500 soldats. Le conteneur a une fonction extensible (trois ouvertures) avec un système mécanique manuel lorsque les équipements sont installés à l'intérieur. Le système extensible peut être refermé aux dimensions ISO lorsqu'il doit être déplacé ou transporté. Il est équipé de four conventionnel, chariot de four, marmite de cuisson, friteuse, plaque à induction, hachoir à viande, mixeur, coupe légumes, éplucheur de pommes de terre, stérilisateur de couteau, table de travail, hotte, évier, poubelle, planche à découper et d'ustensiles (couteau, écumeurs, louches, etc.).

- ▷ Le sol est recouvert d'un revêtement en aluminium d'une épaisseur de 2/3 mm. Avec une membrane d'étanchéité, sous le revêtement de sol.
- ▷ Les surfaces des parois intérieures du conteneur sont recouvertes d'acier inoxydable.

▷ Konteynerlerin iç duvar yüzeyleri paslanmaz sac kaplıdır.

▷ Konteynerde;

- Kısa kenarlarının birinde tek kanatlı dış kapı
- 12000 (on iki bin) BTU kapasitesinde inverter klima.
- 1 adet 2000 W gücünde elektrikli ısıtıcı.
- Beraber taşınabilir 3000 lt kapasiteli 1 asıl ve 1 yedek temiz su tankı.
- Elektrik olmadığında sistemin çalışabilmesini sağlayacak kapasitede dizel jeneratör.
- Mutfak malzemelerini yıkayacak kapasitede 1 adet bulaşık makinesi.
- 600 litrelik erzakı muhafaza edebilecek yapıda soğutucu mevcuttur.

▷ The inner wall surfaces of the containers are stainless steel covered.

▷ There is a single wing outer door on one of the short sides of the container.

▷ The container has an inverter air conditioner with a capacity of 12000 (twelve thousand) BTU. There is a 2000 W electric heater in the container.

▷ 1 main and 1 spare clean water tank with 3000 lt capacity, portable with container

▷ Diesel generator with the capacity to operate the system when there is no electricity in the container.

▷ 1 dishwasher with the capacity to wash kitchen utensils in the kitchen container

▷ Cooler in a container that can hold at least 600 liters of food. It is diesel fueled.

▷ Il y a une porte extérieure à un seul battant sur l'un des côtés court du conteneur.

Le conteneur dispose :

▷ D'un climatiseur inverter d'une capacité de 12000 BTU, d'un radiateur électrique de 2000 W.

▷ D'un réservoir principal et d'un réservoir secondaire d'eau potable

▷ D'une capacité de 3000 lt, portable.

▷ D'un générateur diesel ayant la capacité de faire fonctionner le système lorsqu'il n'y a pas d'électricité dans le conteneur.

▷ D'un lave-vaisselle pouvant laver les ustensiles et batteries de cuisines

▷ D'un congélateur pouvant contenir au moins 600 litres de denrées alimentaires. Il est alimenté au diesel.

SEYYAR SAHRA MUTFAK ÜNİTESİ FIELD KITCHEN UNIT

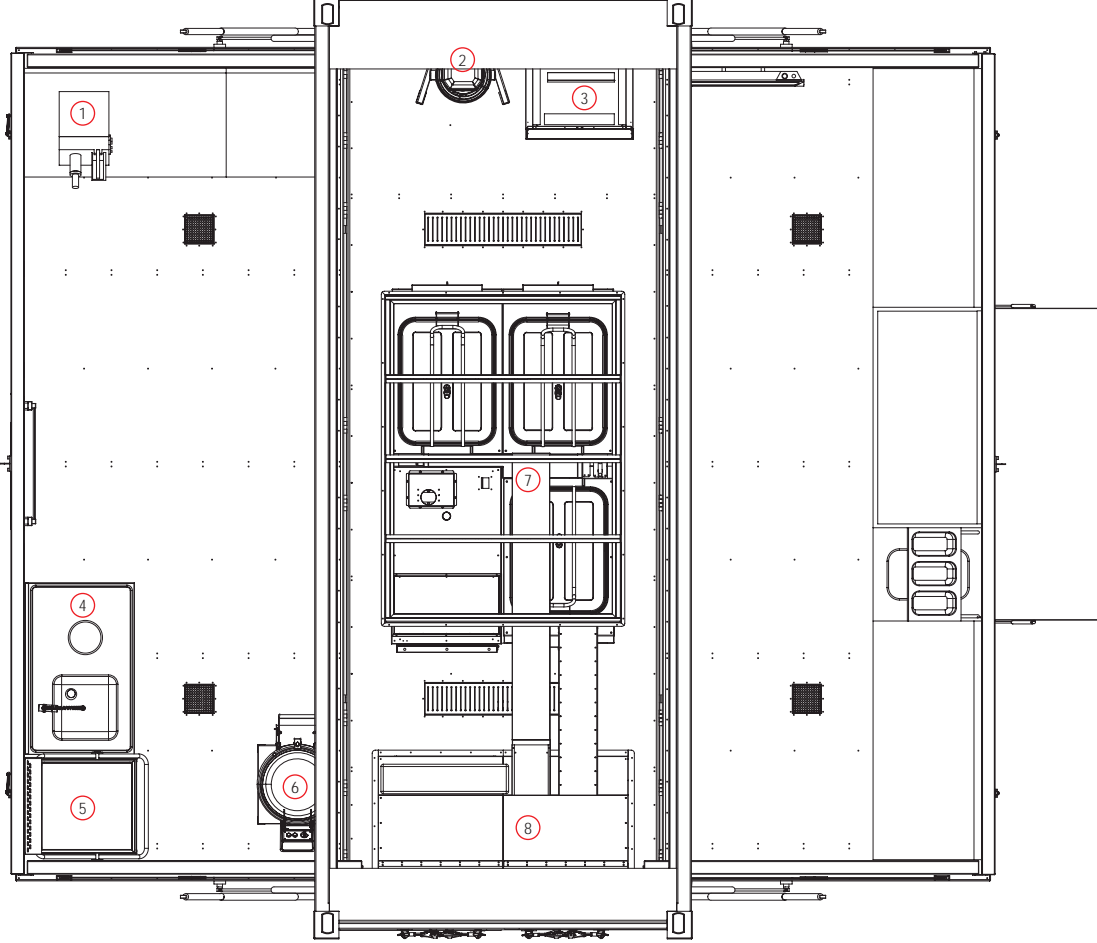

TR	EN	FR	
1	Sebze Doğrama Makinesi	Vegetable Cutting Machine	Coupe Légumes
2	Mikser	Mixer	Mixeur
3	Buzdolabı	Refrigerator	Réfrigérateur
4	Çalışma Tezgahı	Working Bench	Table de Travail
5	Bulaşık Makinesi	Dishwasher	Lave vaisselles
6	Patates Soyma Makinesi	Potato Peeler	Eplucheur de pommes de terres
7	Pişirme Ekipmanları	Cooking Island	Fourneau de cuissons
8	Klima İç Ünitesi	A/C Internal Unit	Unité intérieur de climatisation







TR Fırın 8 saatte 6240 adet (150 gr'lık) ekmek pişirebilecek kapasitededir. Fırın ünitesi hazırlık, pişirme ve dinlendirme konteyneri olmak üzere 3 (üç) konteynerden oluşmaktadır.

- 1- Hazırlık Ünitesi: Hamur yoğurma makinası (Mixer), kesme makinası, konik yuvarlama makinası ve ara dinlendirme bölümü
- 2- Pişirme Ünitesi: Döner Fırın, tava arabası ve mayalandırma kabini
- 3- Dinlendirme Ünitesi: Ekmek sepetleri mevcuttur.

▷ Taban döşemesi üzeri, en az 2/3 (iki taksim üç)mm kalınlığında çetalı alüminyum yer kaplaması ile sızdırmaz olacak şekilde kaplanmıştır.

- ▷ Taban döşeme altına membranla su yalıtımı sağlanmıştır.
- ▷ Konteynerlerin iç duvar yüzeyleri paslanmaz sac kaplıdır.
- ▷ Fırın ünitesinde elektrik olmadığı zamanlarda sistemin çalışabilmesini sağlayacak kapasitede dizel jeneratör mevcuttur.
- ▷ Konteynere entegre edilmiş veya beraber taşınabilen en az 2000 lt kapasiteli bir asıl ve bir yedek temiz su tankı mevcuttur.

EN The oven has the capacity to bake 6240 pieces (150 gr) of bread in 8 hours. The oven unit consists of 3 (three) containers: preparation, cooking and resting container.

- 1-Preparation Unit: Cutting machine, rounding machine, automatic spiral mixer, intermediate resting cabinet.
- 2-Cooking Unit: Rotating oven, pan trolley, fermentation cabinet.
- 3-Resting Unit: Bread baskets

▷ The floor covering is covered to be leak-proof with a chelated aluminum floor covering with a thickness of at least 2/3 (two parts three) mm.

- ▷ Under the floor covering, membrane waterproofing is provided.
- ▷ The inner wall surfaces of the containers are covered with stainless sheet.
- ▷ There is a diesel generator with the capacity to operate the system when there is no electricity.
- ▷ There is one main and one spare clean water tank with 2000 lt capacity, which can be integrated into the container and transported together.

FR La boulangerie a la capacité de cuire 6240 pains (150 gr) en 8 heures. L'unité de Boulangerie se compose de 3 Conteneurs : préparation, cuisson et repos.

- 1-Unité de préparation : Pétrin à spirale, diviseur de pate, boule use, armoire de repos intermédiaire.
- 2-Unité de cuisson : four rotatif, chariot à plateaux, armoire de fermentation.
- 3-Unité de repos : paniers à pain.

▷ Le sol est recouvert d'un revêtement en aluminium chélate d'une épaisseur de 2/3 mm.

- ▷ Avec une membrane d'étanchéité, sous le revêtement de sol.
- ▷ Les surfaces des parois intérieures du conteneur sont recouvertes d'acier inoxydable.
- ▷ Il y a un générateur diesel ayant la capacité de faire fonctionner le système lorsqu'il n'y a pas d'électricité.
- ▷ Il y a un réservoir principal et un réservoir secondaire d'eau potable d'une capacité de 2000 lt, qui peuvent être transporté avec le conteneur.

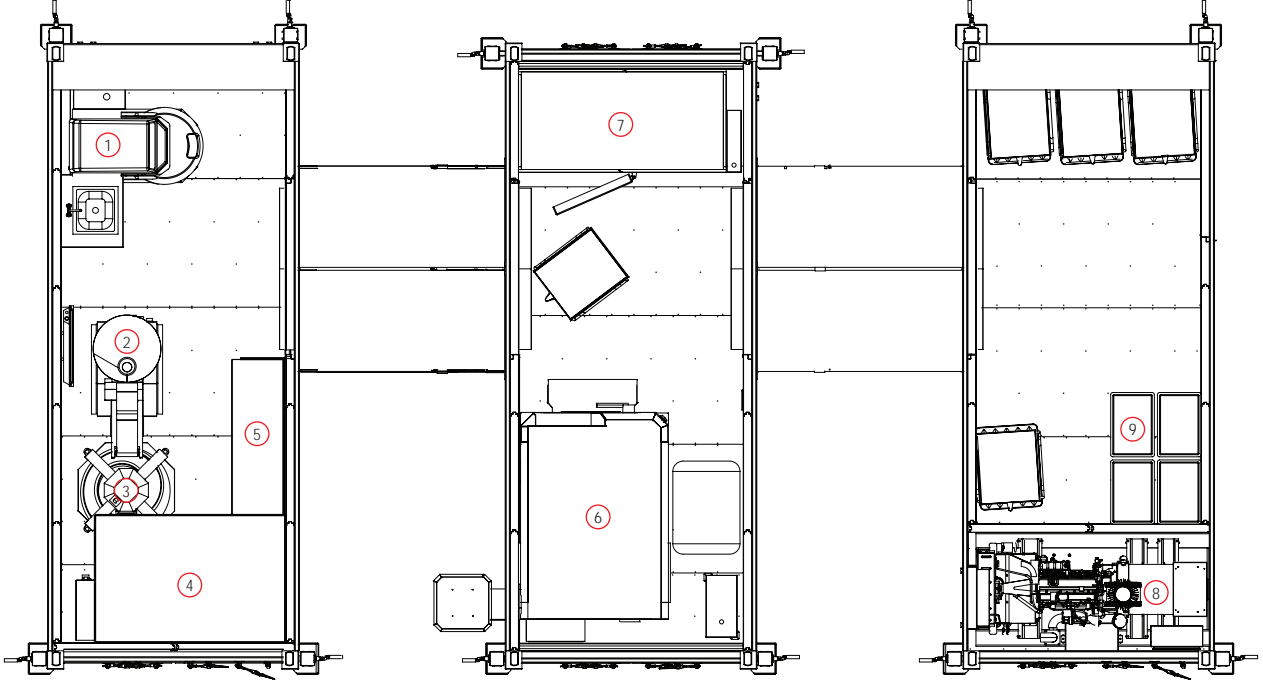

TR	EN	FR
1	Spiral Mixer	Pétrin à spirale
2	Dough Divider	Diviseur de pate
3	Dough Rounding	Bouleuse de pate
4	Dough Resting	Repose pate
5	Working Bench	Table de travail
6	Rotating Oven	Four rotatif
7	Fermentation Cabinet	Armoire de fermentation
8	Diesel Generator	Générateur diesel
9	Bread Baskets	Panier a pains







TR

Konteyner içerisinde 8 adet duş bölmesi vardır. Duş bölümlerinin taban döşemesi 1.5 mm kalınlığında paslanmaz malzeme ile kaplanmıştır, dış kapı konteynerin kısa kenarındadır ve diğer kısa kenarda ise teknik oda bulunmaktadır. Duş bataryası, el ayarı ile sıcak soğuk su karışımı yapabilir. Soğuk su tesisatı, şebekeden veya depodan su teminine uygundur. Duş, yer süzgeci ve lavabo pis su giderleri birleştirilerek tek çıkış olarak verilmiştir. Duş bölmelerinde;

- Paslanmaz köşe tip süngerlik (Tekli),
- Dört adet havlu askısı, kapı iç tarafına monte edilmiş
- Duş bataryası,
- Duş panelleri
- Duş kapısı
- Askıya asılacak kıyafetleri sudan koruma amaçlı ıslak alan ile kapı arasında duş perdesi mevcuttur.

EN

There are 8 shower cubicles. The floor of the shower sections is covered with 1.5 mm thick stainless material. The outer door is on the short edge of the container and other short side, there is a technical room. The shower faucet can mix hot cold water with hand adjustment. Equipment to prevent freezing of water in the tank in cold weather. Cold water installation to suitable for water supply from the network or water tank. Shower, floor drain and sink waste water expenses are combined and given as one outlet.

- Stainless corner type sponge holder (Single),
- Four towel racks, mounted on the inside of the door.
- Shower faucet,
- Shower panels
- Shower door
- Shower curtain between wet area and door to protect the clothes to be hung from the hanger from water

FR

Les sections de douche sont recouvert d'acier inoxydable de 1,5 mm d'épaisseur. La porte extérieure est sur le bord court du conteneur, sur l'autre côté court se trouve le local technique. Il y a 8 cabines de douche. Le réglage manuel du robinet de douche permet la régulation eau chaude et froide. Installation approprié pour l'approvisionnement en eau froide par le réseau ou par le réservoir. Les eaux usées des douches, lavabos et caniveaux sont reliées à une seule sortie.

- Plinthe de coin en acier inoxydable,
- Quatre porte-serviettes, montés à l'intérieur de la porte,
- Robinet de douche,
- Panneaux de douche,
- Porte de douche,
- Rideau de douche entre la zone humide et la porte pour protéger les vêtements suspendus au cintre.



- ▷ Soğuk havalarda depodaki suyun donmasını engelleyici donanım.
- ▷ Su çıkış basıncını artırıcı hidrofor sistemi.
- ▷ Suyun ısınması; dizel ısıtma sistemi.
- ▷ Sıhhi tesisatın soğuk ve sıcak su girişi ile pis su çıkışları.
- ▷ Konteynerde elektrik olmadığı zamanlarda sistemin çalışabilmesini sağlayacak kapasitede dizel jeneratör.
- ▷ Konteyner ile beraber taşınabilen 7.000 (yedi bin) Lt. kapasiteli 1 asılı ve 1 yedek temiz su tankı mevcuttur.

- ▷ Equipment to prevent freezing of water in the tank in cold weather.
- ▷ There should be a booster system to increase the water outlet pressure.
- ▷ Heating of water; it is provided with diesel heating system.
- ▷ The sanitary installation has cold, hot water inlets and dirty water outlets.
- ▷ There is a diesel generator with the capacity to operate the system when there is no electricity in the container.
- ▷ 7,000 Lt. Capacity one main and one spare fresh water tank

- ▷ Équipement empêchant le gel de l'eau dans le réservoir par temps froid.
- ▷ Système d'hydrophore augmentant la pression de sortie d'eau.
- ▷ Chauffage de l'eau, par un système de chauffage diesel.
- ▷ Installation sanitaire avec entrée d'eau froide, eau chaude et sorties des eaux usées.
- ▷ Il y a un générateur diesel ayant la capacité de faire fonctionner le système lorsqu'il n'y a pas d'électricité.
- ▷ Il y a un réservoir principal et un réservoir secondaire d'eau potable D'une capacité de 7000 lt, qui peuvent être transporté avec le conteneur.

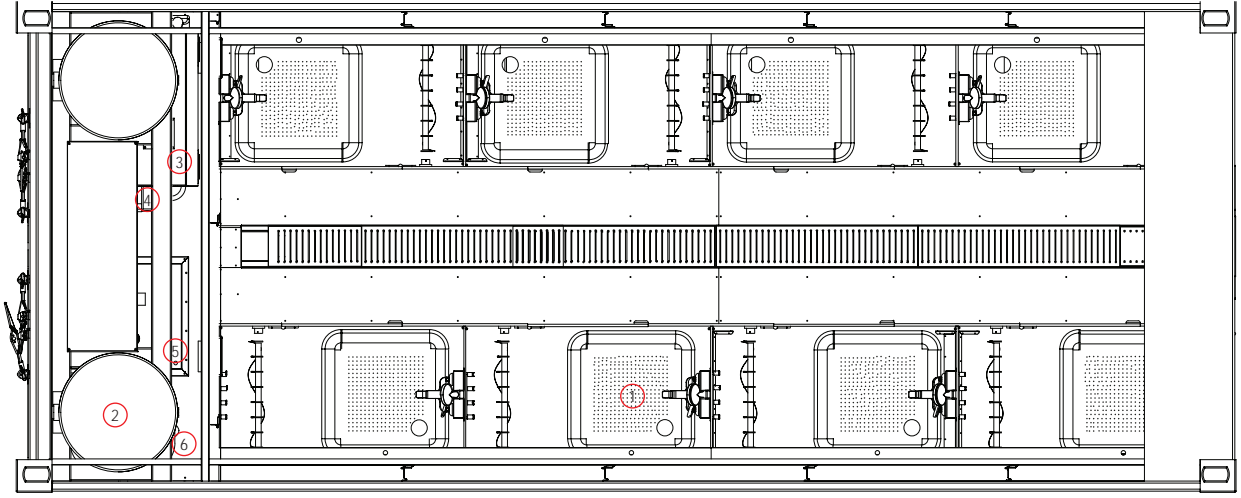
SEYYAR SAHRA BANYO ÜNİTESİ FIELD SHOWER UNIT



	 TR	 EN	 FR
1	Duş Kabini	Shower Cubicles	Cabines de douche
2	Boylar (2 Adet)	Boiler (2 pcs)	Chaudière (2 pcs)
3	Dizel Jenerator	Diesel Generator	Générateur diesel
4	Dizel Su Isıtıcı	Diesel Heater	Chauffe-eau diesel
5	Atık Su Pompası	Dirty Water Pump	Pompe eaux usées
6	Temiz Su Dirofor Sistemi	Clean Water Booster System	Système d'hydrophore d'eau propre







TR

Konteyner içerisinde 10 adet hela bölümü bulunmaktadır. Taban döşemesi üzeri, sızdırmaz olacak şekilde 2/3 mm kalınlığında çetalı alüminyum yer kaplaması ile kaplanmıştır. Taban döşeme altına membranla su yalıtımı sağlanmıştır. Tek kanatlı dış kapı, konteynerin kısa kenarlarından birinde dışa açılacak şekilde tasarlanmıştır. Soğuk su tesisatı, şebekeden veya depodan su teminine uygundur. Yer süzgeci ve lavabo pis su giderleri birleştirilerek tek çıkış olarak verilmiştir.

Her bölme içerisinde;

- Paslanmaz çelik tuvalet taşı
- Tekli askılık
- Musluk
- Paslanmaz çelik lavabo,
- Lavabo bataryası,
- Her bir lavabo için flotat ayna
- Tuvalet kağıdı tutacağı

EN

There are 10 cubicles in the container, The floor is covered with a 2/3 mm thick aluminum floor covering. Under the floor covering, membrane waterproofing is provided. On one of the short sides of the container, there is a single wing outer door to open outwards. Cold water installation is suitable for water supply from the network or water tank. Floor drain and sink waste water are combined and given as one outlet.

In each compartment;

- Stainless steel toilet base
- Single hanger
- Faucets
- Stainless steel basin in suitable dimensions,
- Sink battery,
- Flotat mirror for each sink
- Toilet paper holder

FR

Il y a 10 compartiments dans le conteneur. Le sol est recouvert d'un revêtement en aluminium d'une épaisseur de 2/3 mm. Avec une membrane d'étanchéité, sous le revêtement de sol. Il y a une porte extérieure à un seul battant sur l'un des côtés court du conteneur, a ouverture vers l'extérieur. Installation approprié pour l'approvisionnement en eau froide par le réseau ou par le réservoir. Les eaux usées des lavabos et caniveaux sont reliées à une seule sortie.

Et dans chaque compartiment:

- Base de toilette en acier inoxydable
- Cintre simple
- Robinet
- Lavabo en acier inoxydable aux dimensions appropriées,
- Batterie de lavabo,
- Miroir flotat pour chaque lavabo

- Havluluk
- Çöp kovası
- Tuvalet fırçası
- Sıvı sabunluk mevcuttur.

- ▷ Soğuk havalarda suyun donmasını engelleyecek donanımı.
- ▷ Su çıkış basıncını artırıcı hidrofor sistemi.
- ▷ Sıhhi tesisatın soğuk ve sıcak su girişi ile pis su çıkışları .
- ▷ Konteynerle beraber taşınabilir 3500 Lt. kapasiteli 1 asıl ve 1 yedek temiz su tankı
- ▷ Konteynerde elektrik olmadığı zamanlarda sistemin çalışabilmesini sağlayacak kapasitede dizel jeneratör mevcuttur.

- Towel hanger
- Trash can
- Toilet brush
- Liquid soap dispenser



- ▷ There is equipment to prevent water from freezing in cold weather.
- ▷ Booster system to increase the water outlet pressure.
- ▷ Cold and hot water inlet and waste water outlets of the sanitary system.
- ▷ 3500 Lt. portable with container 1 main and 1 spare clean water tank with a capacity
- ▷ Diesel generator with the capacity to operate the system when there is no electricity in the container

- Distributeur de papier toilettes
- Serviette
- Poubelle
- Brosse de toilette
- Distributeur de savon liquide

- ▷ Équipement empêchant le gel de l'eau dans le réservoir par temps froid.
- ▷ Système d'hydrophore augmentant la pression de sortie d'eau. Installation sanitaire avec entrée d'eau froide, eau chaude et sorties des eaux usées.
- Il y a un réservoir principal et un réservoir secondaire d'eau potable
- ▷ d'une capacité de 3500 lt, qui peuvent être transporté avec le conteneur. Il y a un générateur diesel ayant la capacité de faire fonctionner le système lorsqu'il n'y a pas d'électricité.

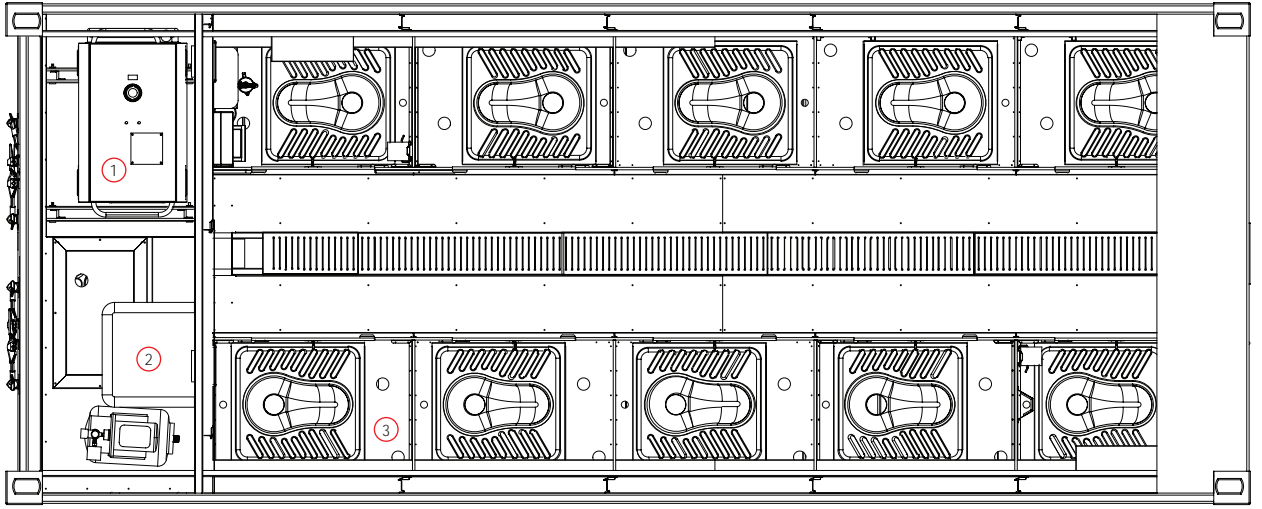
SEYYAR HELA VE EL-YÜZ YIKAMA ÜNİTESİ
TOILET AND SANITARY UNIT



	 TR	 EN	 FR
1	Dizel Jeneratör	<i>Diesel Generator</i>	<i>Générateur diesel</i>
2	Su Tankı	<i>Water Tank</i>	<i>Réservoir d'eau</i>
3	Tuvalet Bölmesi (10 Adet)	<i>Cubicles (10 pcs)</i>	<i>Compartiments toilette (10 pcs)</i>







Konteyner içerisinde 2 adet 20 kg. kapasiteli yıkama ve 2 adet 20 kg kapasiteli kurutma makinesi bulunmaktadır. Taban döşemesi üzeri, sızdırmaz olacak şekilde 2/3 mm. kalınlığında çetali alüminyum yer kaplaması ile kaplanmıştır. Taban döşeme altına membranla su yalıtımı sağlanmıştır. Konteyner iç duvar yüzeyleri paslanmaz sac kaplanmıştır.

- ▷Konteynerin uzun kenarında çift kanatlı dış kapı
- ▷Konteynerle beraber taşınabilir 2000 lt kapasiteli bir asıl ve bir yedek temiz su tankı
- ▷1 adet 2000 W gücünde elektrikli ısıtıcı.

- ▷İçerisinde paslanmaz sacdan imal edilmiş 2 adet duvara asılan tipte kayar kapaklı metal dolap
- ▷İçerisinde temiz ve kirli çamaşırları koyabilmek için 4 adet çamaşır sepeti
- ▷Elektrik olmadığı zamanlarda sistemin çalışabilmesini sağlayacak kapasitede dizel jeneratör .



There are 2 pieces washing machines and 2 dryers with 20 kg capacity each. 2/3 mm floor is covered with thick aluminum floor covering. Under the floor covering, membrane waterproofing is provided. Container inner wall surfaces are covered with stainless steel.

- ▷Double wing outer door on the long edge of the container.
- ▷One main and one spare clean water tank with 2000 lt capacity, portable with container
- ▷One 2000 W electric heater in the container.

- ▷Metal Cupboard with sliding doors made of stainless steel.
- ▷20 kg capacity laundry baskets to put clean and dirty laundry.
- ▷Diesel generator with the capacity to operate the system when there is no electricity.



2 Lave-linges cap. 20 kg et 2 sèche-linges cap. 20 kg. Le sol est recouvert d'un revêtement en aluminium chélate d'une épaisseur de 2/3 mm. Avec une membrane d'étanchéité, sous le revêtement de sol. Les surfaces des parois intérieures du conteneur sont recouvertes d'acier inoxydable.

- ▷Il y a une porte extérieure à un double battant sur l'un des côtés longs du conteneur.
- ▷Il y a un réservoir principal et un réservoir secondaire d'eau potable d'une capacité de 2000 lt, qui peuvent être transporté avec le conteneur.

- ▷Il y a un radiateur électrique de 2000 W dans le conteneur,
- ▷Armoire en métal avec portes coulissantes en acier inoxydable,
- ▷Paniers à linges cap. 20 kg pour ranger le linge propre et sale,
- ▷Il y a un générateur diesel ayant la capacité de faire fonctionner le système lorsqu'il n'y a pas d'électricité.

SEYYAR SAHRA ÇAMAŞIR YIKAMA ÜNİTESİ
FIELD LAUNDRY UNIT

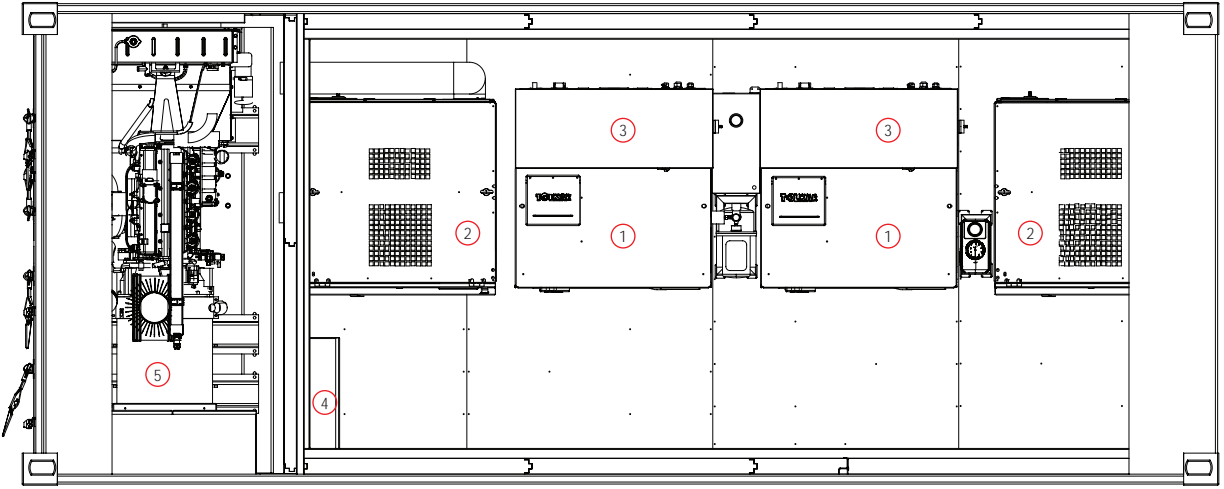

TR	EN	FR	
1	Çamaşır Yıkama Makinesi (2 Adet)	Washin Machines (2 pcs)	Lave-linges (2 pcs)
2	Kurutma Makinası (2 Adet)	Dryer (2 pcs)	Sèche-linges (2 pcs)
3	Malzeme Dolabı (2 Adet)	Cupboard (2 pcs)	Armoires (2 pcs)
4	Konvektör Isıtıcı	A/C	Radiateur électrique
5	Dizel Jeneratör	Diesel Generator	Générateur diesel



لشانه‌های استیل





TR

2 adet 1000 tabak/ saat kapasiteli, en az 3 programlı giyotin tip bulaşık makinası mevcuttur .Taban döşemesi üzeri, sızdırmaz olacak şekilde en az 2/3 mm kalınlığında çetallı alüminyum yer kaplaması ile kaplanmıştır. Taban döşeme altına membranla su yalıtımı ve ıslak zemine uygun, kaymaya karşı, zemin ve duvarlar anti bakteriyel özelliklerdedir. Konteynerin kısa kenarlarının birinde yerleştirilmiş çift kanatlı dış kapı mevcuttur.

- ▷ 200 m3/Saat kapasiteli havalandırma fanı
- ▷ Konteynerle beraber taşınabilir 3500 lt kapasiteli 1 asıl ve 1 yedek temiz su tankı
- ▷ Su tankı ve su tesisatı için donmayı engelleyecek yalıtım sistemi
- ▷ Konteynerde elektrik olmadığı zamanlarda sistemin çalışabilmesini sağlayacak kapasitede dizel jeneratör

EN

2 pieces of 1000 plate / hour capacity, at least 3 program guillotine type dishwasher. The floor is covered with an aluminum floor covering with a minimum thickness of 2/3 mm that is leakproof. Membrane waterproofing under the floor covering. Floors and walls suitable for wet ground, anti-slip, anti-bacterial properties. Double wing outer door on one of the short sides of the container.

- ▷ 200 m3 / h capacity ventilation fan
- ▷ 1 main and 1 spare clean water tank with a capacity of 3500 lt.
- ▷ Diesel generator with the capacity to operate the system when there is no electricity in the container.
- ▷ 2 pieces of 1000 plate / hour capacity, at least 3 program guillotine type dishwasher.
- ▷ Stacking rack for materials.

FR

2 lave-vaisselles à capot d'une capacité de 1000 assiettes/heure, avec au moins 3 programmes. Le sol est recouvert d'un revêtement en aluminium chélate d'une épaisseur de 2/3 mm. Avec une membrane d'étanchéité, sous le revêtement de sol. Sols et murs adaptés à l'humidité, avec des propriétés antidérapantes, et antibactériennes. Il y a une porte extérieure à un double battant sur l'un des côtés court du conteneur.

- ▷ Ventilateur d'une capacité de 200 m3/h
- ▷ Il y a un réservoir principal et un réservoir secondaire d'eau potable.
- ▷ D'une capacité de 3500 lt, qui peuvent être transporté avec le conteneur.
- ▷ Il y a un générateur diesel ayant la capacité de faire fonctionner le système lorsqu'il n'y a pas d'électricité.

- ▷ Malzemelerin istiflenmesi için istif rafı.
- ▷ Tabaklardaki artıkların temizlenebilmesi için çöp arabası ve bulaşık sıyırma tezgâhı.
- ▷ Konteyner içerisinde kazan yıkamaya elverişli yıkama tezgâhı/evyesi
- ▷ 1 adet 2,5 m genişliğinde kazan yıkama evyesi.
- ▷ Tezgaha entegre edilmiş ön yıkamalar ve kazan yıkama için sprey yıkama hortumu.
- ▷ Bulaşık makineleri giriş tezgâhında ön yıkama için sprey yıkama hortumlu giriş tezgâhı.
- ▷ Gideri tek noktada birleştirilerek dışarıya atabilen atık su sistemi.

- ▷ Garbage bin and dish scraper to remove scraps from plates
- ▷ Washing table / sink suitable.
- ▷ 2.5 m wide bowl washing sink.
- ▷ Spray wash hose for prewashes and container washing integrated in the counter
- ▷ Entry bench with spray washing hose for pre-washing at the dishwasher entrance bench
- ▷ The system that can combine the waste water at a single point and throw it out

- ▷ 2 lave-vaisselles à capot d'une capacité de 1000 assiettes/heure, avec au moins 3 programmes.
- ▷ Etagère de rangement pour le matériel,
- ▷ Poubelle et table avec trou vide ordures pour le nettoyage des assiettes,
- ▷ Table et évier adapté au lavage des batteries de cuisines,
- ▷ Evier de 2,5 m de large, pour le lavage des batteries,
- ▷ Spray pour prélavages et lavage intégré dans les éviers,
- ▷ Spray de lavage intégré dans les tables d'entrée lave-vaisselles,
- ▷ Un système qui relie les eaux usées en un seul point de sortie.

SEYYAR SAHRA BULAŞIK YIKAMA ÜNİTESİ FIELD DISH WASHING UNIT

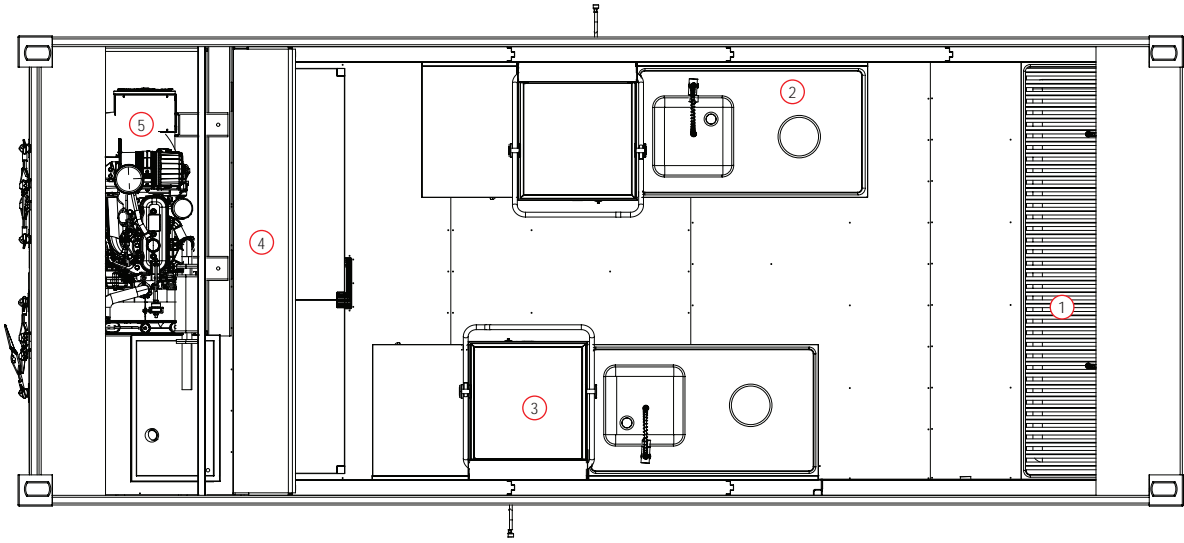

TR	EN	FR
1 Kazan Yıkama Evyesi	Washing Sink	Paniers plastiques
2 Sıyırma Tezgahı	Scraper	Table d'entrée avec trou vide ordures
3 Bulaşık Makinesi	Dishwasher	Lave-vaisselles à capot
4 İstifleme Rafı	Stacking Rack	Etagères
5 Dizel Jeneratör	Diesel Generator	Générateur diesel







TR

Sistem saatte en az 500 lt. ve günlük olarak en az 9000 lt içme suyu verebilmektedir. Tatlı su ve deniz suyunu arıtabilir. Taban döşemesi üzeri, sızdırmaz olacak şekilde en az 2/3 mm kalınlığında çetalı alüminyum yer kaplaması ile kaplanmıştır. Taban döşeme altına membranla su yalıtımı yapılmıştır. Konteynerin uzun kenarlarının birinde tek kanatlı dış kapı bulunmaktadır. Sistem her türlü doğal su kaynaklarını kullanabilmektedir.

- ▷ Su deposu iç yüzeyleri AISI 304 kalite paslanmaz çelikten üretilmiştir.
- ▷ 1 adet 2000 W gücünde elektrikli ısıtıcı.
- ▷ Su kaynaklarından su çekebilecek ve arıtılmış suyu su tanklarına basabilecek pompa ve pompa grubu.

EN

The system can purify 500 lt. per hour an 9000 Lt per day at least. The floor covering is covered with an aluminum floor covering with a thickness of at least 2/3 mm to be leak-proof. Membrane waterproofing under the floor covering. Single wing outer door on one of the long sides of the container. The system is equipped to work in all kinds of natural water resources.

- ▷ Water tank inner surfaces are AISI 304 quality stainless steel.
- ▷ 2000 W electric heater in the container.
- ▷ Pump and pump group that can draw water from water sources and press the treated water into water tanks.

FR

Le système peut purifier au moins 9000 Lt d'eau en eau potable par jour, Le sol est recouvert d'un revêtement en aluminium chélate d'une épaisseur de 2/3 mm. Avec une membrane d'étanchéité, sous le revêtement de sol. Il y a une porte extérieure à un seul battant sur l'un des côtés longs du conteneur. Le système est équipé pour fonctionner avec tous types sources d'eau naturelles.

- ▷ Les parois intérieures du réservoir d'eau sont acier inoxydable de qualité AISI304.
- ▷ Chauffage électrique de 2000 W dans le conteneur,
- ▷ Pompe et groupe de pompes pouvant absorber l'eau de sources et transférer l'eau potable traitée dans les réservoirs,

- ▷ UV (mor ötesi) ve ters ozmos ile arıtma sistemi.
- ▷ Konteyner içerisinde arıtılmış suyu muhafaza edecek kapasitede
- ▷ 5 adet 1000 litrelik depo
- ▷ Depo içindeki suyun donmasını önleyecek ısıtma sistemi.
- ▷ Arıtılmış suyu ilave depolayabilmek için katlanabilir özellikte 5.000 litre kapasiteli kauçuk su tankı.
- ▷ Elektrik olmadığı zamanlarda sistemin çalışabilmesini sağlayacak kapasitede dizel jeneratör mevcuttur.

- ▷ Purification system with UV (ultraviolet) and reverse osmosis.
- ▷ There are 5 1000 liter tanks in the container with the capacity to preserve purified water.
- ▷ Heating system to prevent freezing of water in the tank.
- ▷ Foldable 5.000 liter capacity rubber water tank for additional storage water purified.
- ▷ Diesel generator with the capacity to operate the system when there is no electricity in the container.

- ▷ Système de purification par UV (ultraviolet) et osmose inversé,
- ▷ 5 réservoirs d'une capacité de 1000 litres pour conserver l'eau purifiée,
- ▷ Système de chauffage pour empêcher l'eau dans le réservoir de geler,
- ▷ Réservoir d'eau en caoutchouc pliable d'une capacité de 5.000 litres pour un stockage supplémentaire,
- ▷ Générateur diesel ayant la capacité de faire fonctionner le système lorsqu'il n'y a pas d'électricité.

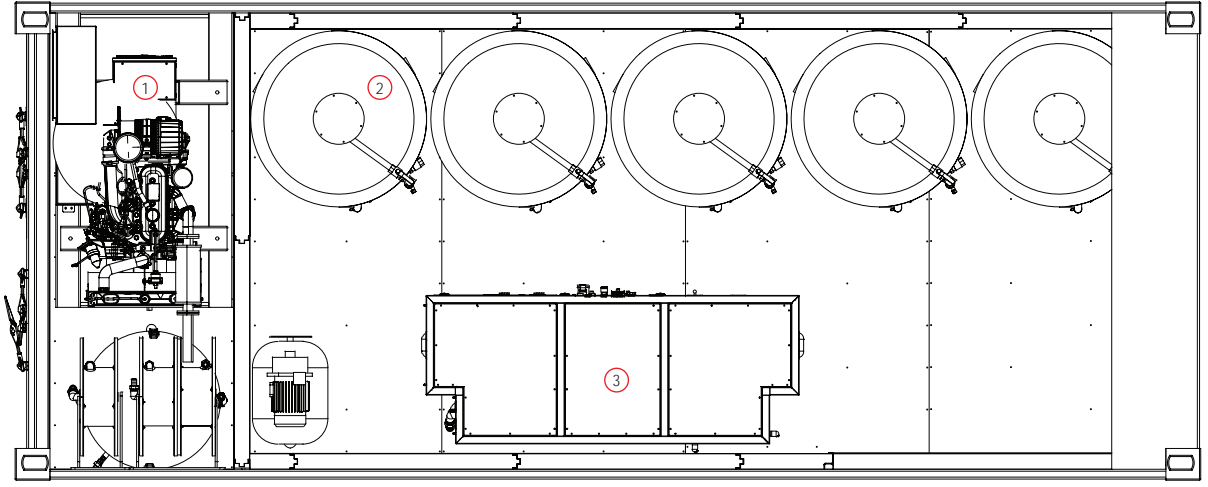

TR	EN	FR	
1	Dizel Jeneratör	Diesel Generator	Générateur diesel
2	Temiz Su Tankları (5 Adet)	Clean Water Tank (5 pcs)	Réservoir d'eau potable (5 pcs)
3	Ters Ozmos Su Arıtma Cihazı	Water Purifying System	System de purification par osmose



TR Suda ki amonyum, karbonat sertliği, demir, nitrat, nitrit, pH, bulanıklık, fosfat ve sertlik değerlerini tespit edebilmek için kullanılmaktadır. Kimyasal, fiziksel ve mikrobiyolojik test yapabilmektedir. İnsan sağlığını olumsuz etki eden zararlı maddeleri tesbit edip, elde edilen verileri hafızasında saklayabilmektedir. Su analiz seti uygun bir dolapta muhafaza edilebilir ve çanta içerisinde taşınabilir.

EN It is used to determine phosphate and hardness values, ammonium, carbonate hardness, iron, nitrate, nitrite, pH, turbidity in the water. It can perform chemical, physical and microbiological tests. It can detect harmful substances that adversely affect human health and store the obtained data in its memory. The water analysis set can be stored in a suitable cabinet and transported in a bag.

FR Il est utilisé pour déterminer les valeurs de l'ammonium, la dureté carbonatée, le fer, le nitrate, le nitrite, le pH, la turbidité, les valeurs de phosphate et de dureté de l'eau. Il peut effectuer des tests chimiques, physiques et microbiologiques. Peut détecter les substances nocives qui nuisent à la santé humaine et stocker les données obtenues en mémoire. Le kit d'analyse de l'eau peut être rangé dans une armoire appropriée et transporté en sac.

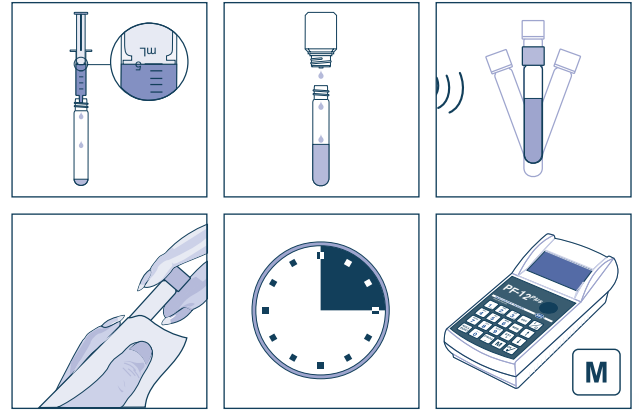





TR Soğuk hava konteyneri 2 odalıdır, iki odaya ilave olarak girişte mekanik ekipmanların yerleştirildiği bir bölüm bulunmaktadır. Tek kanatlı dış kapı konteynerin kısa kenarlarından birine gelecek şekilde tasarlanmıştır. Soğuk hava odalarının duvarları, tavanı ve tabanı 100mm kalınlığında sökülebilir tip poliüretan tecritli panel ile kaplanmıştır. Soğuk hava ünitesi, hava soğutmalı kondenserli paket tip cihaz ile çalışmaktadır. Odalardan birisi $+0^{\circ}\text{C} / +5^{\circ}\text{C}$ arasında diğeri ise $-18^{\circ}\text{C} / -22^{\circ}\text{C}$ derece ısı aralığına sahiptir. Her soğuk hava odası, elektronik kontrol paneli ile programlanabilmektedir. Soğutma sistemi, üzerindeki dijital termostat vasıtasıyla ayarlanan sıcaklık derecesine kadar çalışıp otomatik olarak durur.

Defrost sistemi, soğutucu üzerinde fazla buzlanma oluştuğu zaman otomatik olarak devreye girer. Soğutucunun istenilen sıcaklık ayarı dijital termostat üzerinden yapılabilir. Konteyner içerisindeki soğuk odalarda metal raflar, derin dondurucuda et askı arabası bulunmaktadır. Konteynerde elektrik olmadığı zamanlarda sistemin çalışabilmesini sağlayacak kapasitede dizel jeneratör mevcuttur.

EN Cold air container has 2 rooms. In addition to the two rooms, there is a section at the entrance where mechanical equipment is placed. Single wing outer door on one of the short sides of the container. Removable type polyurethane insulated panels of 100 mm thickness on the floor, ceiling and walls of cold rooms. One of the two rooms can operate between $+0^{\circ}\text{C} / +5^{\circ}\text{C}$ and the other between $-18^{\circ}\text{C} / -22^{\circ}\text{C}$. Each cold room can be programmed with an electronic control panel.

atically. Cooler melts ice with automatic defrost system when there is too much icing on it. The desired temperature setting of the cooler can be made on the digital thermostat. There are metal shelves in cold rooms, meat trolley in deep freezer. Diesel generator with the capacity to operate the system when there is no electricity in the container.



The cooling system operates fully automatically, it works up to the set temperature by means of the digital thermostat on it and stops auto-

FR Le conteneur frigorifique dispose de 2 chambres, en plus des deux chambres, il dispose d'une section où est placé l'équipement mécanique. Il y a une porte extérieure à un seul battant sur l'un des côtés longs du conteneur. Les murs, plafonds et sols des chambres froides sont avec panneaux isolés en polyuréthane de type amovible d'une épaisseur de 100 mm. L'unité d'air froid, fonctionne avec un avec condenseur refroidi par air. Les températures de fonctionnement sont comprises entre $+0^{\circ}\text{C} / +5^{\circ}\text{C}$ pour l'une et $-18^{\circ}\text{C} / -22^{\circ}\text{C}$ pour l'autre. Chaque chambre froide peut être programmée avec un panneau de commande électronique. Le système de refroidissement fonctionne jusqu'à la température réglée

et s'arrête automatiquement grâce à un thermostat numérique. Le système de dégivrage est activé automatiquement, lorsqu'un givre excessif s'accumule sur le refroidisseur. Le réglage de température souhaité du refroidisseur se fait par le thermostat digital. La chambre froide positif est équipée à l'intérieur d'étagères métalliques et la chambre froide négatif de chariot porte-viande. Il y a un générateur diesel ayant la capacité de faire fonctionner le système lorsqu'il n'y a pas d'électricité.

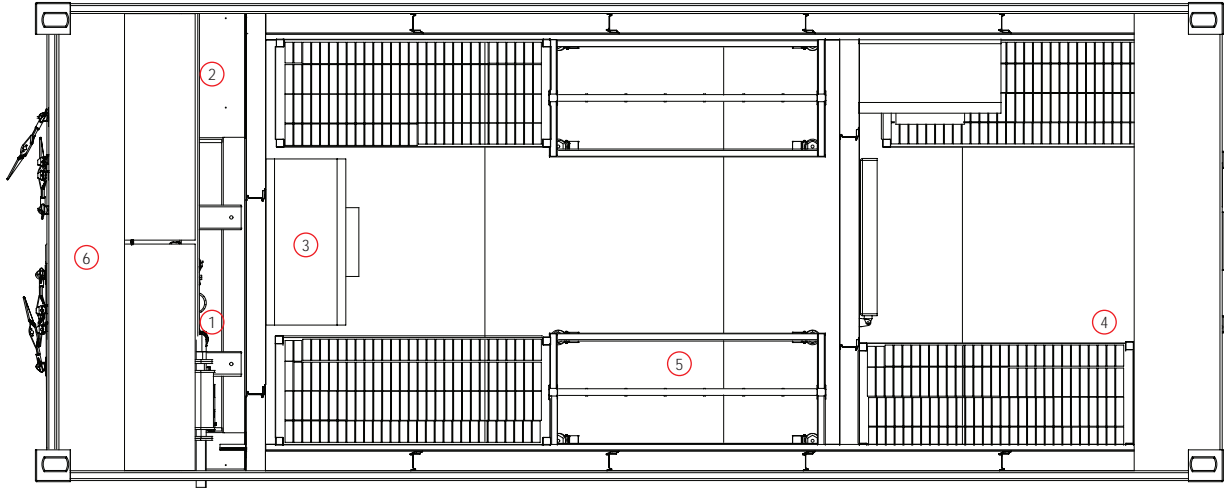
SEYYAR SAHRA SOĞUK HAVA ÜNİTESİ FIELD COLD ROOM UNIT



	 TR	 EN	 FR
1	Dizel Jeneratör	<i>Diesel Generator</i>	<i>Générateur diesel</i>
2	Soğuk Hava Dış Ünitesi (Kondenser)	<i>Condenser</i>	<i>Condenseur</i>
3	Soğutucu (Evaporatör)	<i>Evaporator</i>	<i>Evaporateur</i>
4	Metal Raflar	<i>Metal Racks</i>	<i>Etagères métalliques</i>
5	Et Askı Arabası	<i>Meat Hooking</i>	<i>Chariot porte-viandes</i>
6	Mekanik Ekipman Odası	<i>Technical Room</i>	<i>Local technique</i>



TR

İki bölümden oluşur, biri temiz çamaşır diğeri ise kirlî çamaşır muhafazası bölümüdür. Taban döşemesi üzeri, sızdırmaz olacak şekilde en az 2/3 mm kalınlığında çetalı alüminyum yer kaplaması ile kaplanmış. Taban döşeme altına membranla su yalıtımı sağlanmıştır.

- ▷ Konteynerin kısa kenarlarında tek kanatlı dış kapı.
- ▷ 4 adet 4 sıra raflı metal raf sistemi.
- ▷ 1 adet buharlı pres ütü.
- ▷ 4 adet plastik malzemeden imal edilmiş sepet.

EN

It consists of two sections, one for clean laundry and one for dirty laundry storage. The floor is covered with an aluminum floor covering with a minimum thickness of 2/3 mm that is leakproof. Waterproofing with membrane is provided under the floor covering.

- ▷ There is a single wing outer door on the short sides of the container.
- ▷ 4 shelves metal rack system with 4 rows in the container
- ▷ One press iron
- ▷ 4 laundry baskets

FR

Le sol est recouvert d'un revêtement en aluminium d'une épaisseur de 2/3 mm. Avec une membrane d'étanchéité, sous le revêtement de sol. Il se compose de deux sections, une pour le linge propre et une pour le stockage du linge sale. Il y a une porte extérieure à un seul battant sur l'un des côtés court du conteneur.

- ▷ 4 étagères à 4 rangées métalliques,
- ▷ 1 fer à repasser à vapeur
- ▷ 4 paniers plastiques

SEYYAR ÇAMAŞIR DEPOLAMA ÜNİTESİ LAUNDRY STORAGE UNIT

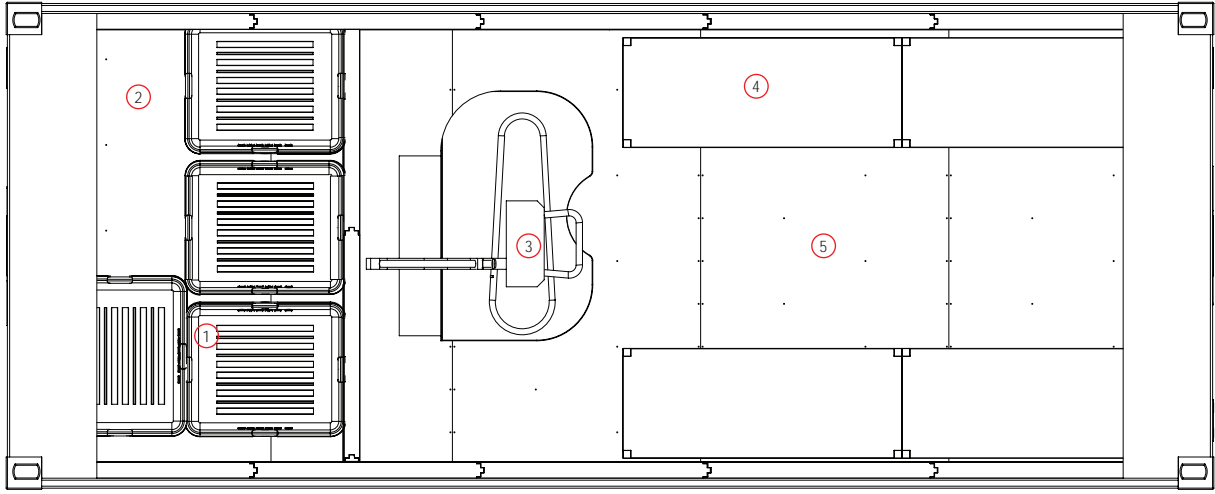

	 TR	 EN	 FR
1	Plastik Sepetler	Plastic Baskets	Paniers plastiques
2	Kirli Çamaşır Depolama Bölümü	Dirty Laundry Area	Zone de linges sales
3	Buharlı Pres Ütü	Pres Ironing	Fer à repasser vapeur
4	Metal Raf Sistemi	Metal Rackets	Etagères métalliques
5	Temiz Çamaşır Depolama Bölümü	Clean Laundry Area	Zone de linges propres

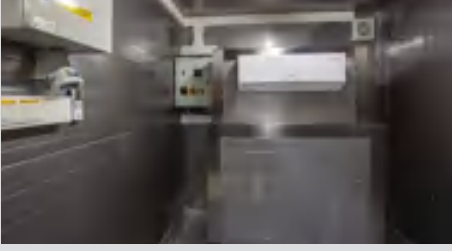
**TR**

Un depolama maksatlı olarak imal edilmiştir. Taban döşemesi üzeri, sızdırmaz olacak şekilde en az 2/3 mm. kalınlığında çetali alüminyum yer kaplaması ile kaplanmıştır. Taban döşeme altına membranla su yalıtımı sağlanmıştır. Konteynerin kısa kenarının birinde tek kanatlı dış kapı vardır. Konteyner içerisinde;

- ▷800x1200 mm ölçülerinde 8 adet plastik palet.
- ▷12000 BTU kapasitesinde inverter klima.
- Konteynerde elektrik olmadığı zamanlarda sistemin çalışabilmesini sağlayacak kapasitede dizel jeneratör mevcuttur.

EN

It used for flour storage. At least 2/3 mm the floor is covered with thick aluminum floor covering. Under the floor covering, membrane waterproofing is provided. Single wing outer door on one of the short sides of the container.

▷8 plastic pallets measuring 800x1200 mm in the container.

- ▷Inverter air conditioner with a capacity of 12000 BTU in the container.
- ▷Diesel generator with the capacity to operate the system when there is no electricity in the container

FR

Le sol est recouvert d'un revêtement en aluminium d'une épaisseur de 2/3 mm. Avec une membrane d'étanchéité, sous le revêtement de sol. Il y a une porte extérieure à un seul battant sur l'un des côtés court du conteneur.



Dans le conteneur :

▷8 palettes en plastique de 800x1200 mm,

- ▷Climatiseur Inverter d'une capacité de 12000 BTU,
- ▷Générateur diesel ayant la capacité de faire fonctionner le système lorsqu'il n'y a pas d'électricité.

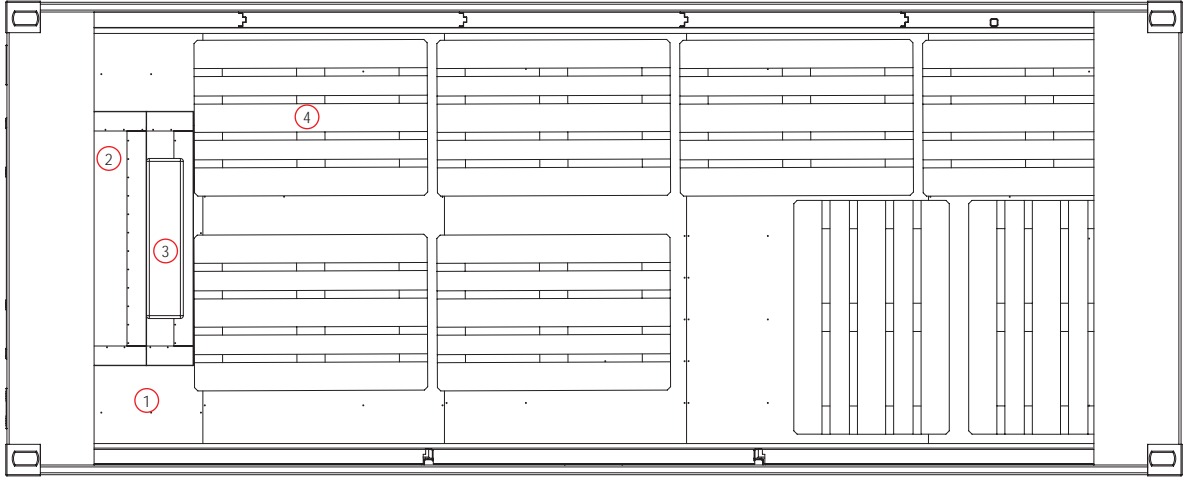
SEYYAR SAHRA UN DEPOLAMA ÜNİTESİ
FIELD FLOUR STORAGE UNIT



	 TR	 EN	 FR
1	Dizel Jeneratör	<i>Diesel Generator</i>	<i>Générateur diesel</i>
2	Havalandırma Menfezi	<i>Air Ventilator</i>	<i>Ventilateur d'air</i>
3	İnvertör Klima	<i>A/C</i>	<i>Climatiseur</i>
4	Plastik Pale	<i>Plastic Pallets</i>	<i>Palettes plastiques</i>



TR Taban döşemesi üzeri, sızdırmaz olacak şekilde 2/3 mm kalınlığında çetali alüminyum yer kaplaması ile kaplanmış, taban döşeme altında membranla su yalıtımı . Konteynerin kısa kenarının birinde çift kanatlı dış kapı yapılmıştır. Konteyner içerisinde

- ▷800x1200 mm ölçülerinde 4 adet plastik palet.
- ▷4 adet, 4 sıra raflı krom çelik metal raf sistemi.
- ▷12000 BTU kapasitesinde inverter klima
- ▷Elektrik olmadığı zamanlarda sistemin çalışabilmesini sağlayacak
- ▷kapasitede dizel jeneratör bulunmaktadır.

EN The floor is covered with a 2/3 mm thick aluminum floor covering. Membrane waterproofing under the floor covering. On one of the short sides of the container, there is a double wing outer door in the container;
▷4 plastic pallets.

- ▷Chrome steel metal shelving system with 4 rows Inverter air conditioner, with 12000 BTU capacity.
- ▷Diesel generator with the capacity to operate the system when there is no electricity in the container

FR Le sol est recouvert d'un revêtement en aluminium d'une épaisseur de 2/3 mm. Avec une membrane d'étanchéité, sous le revêtement de sol. Il y a une porte extérieure double battant sur l'un des côtés court du conteneur.
Dans le conteneur :
▷4 palettes en plastique 800x1200 mm

- ▷4 étagères à 4 rangées métalliques,
- ▷Climatiseur Inverter d'une capacité de 12000 BTU,
- ▷Générateur diesel ayant la capacité de faire fonctionner le système lorsqu'il n'y a pas d'électricité.

SEYYAR SAHRA ERZAK DEPOLAMA ÜNİTESİ FIELD FOOD STORAGE UNIT

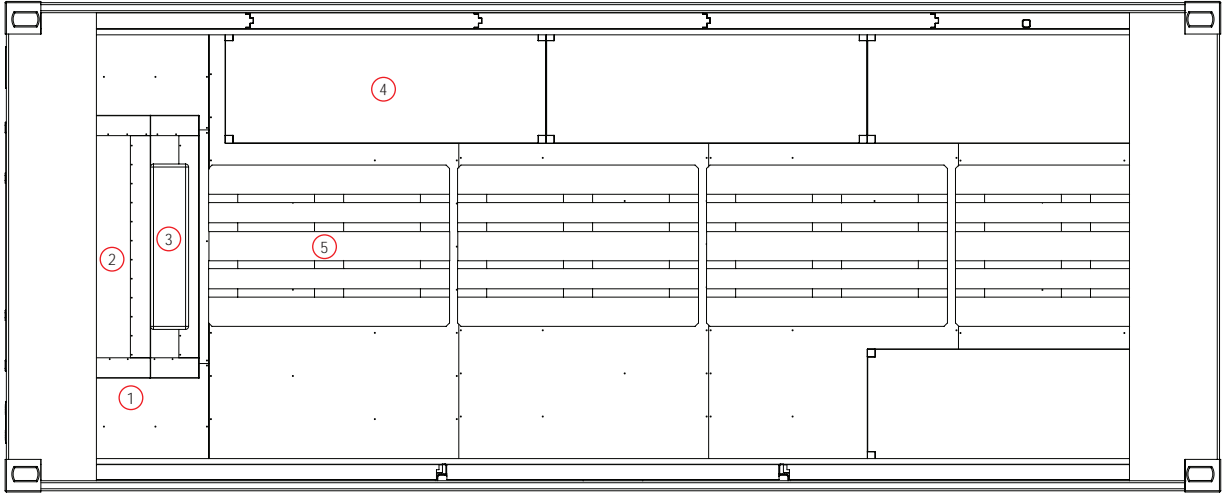

TR	EN	FR	
1	Dizel Jeneratör	Diesel Generator	Générateur diesel
2	Havalandırma Menfezi	Air Ventilator	Ventilateur d'air
3	İnvertör Klima	A/C	Climatiseur
4	Metal Raf Sistemi	Metal Rockes	Etagères métalliques
5	Plastik Palet (4 Adet)	Plastic Pallet (4 pcs)	Palettes plastiques (4 pces)

öztiryakiler

SAVUNMA EKİPMANLARI SAN. TİC. A.Ş.



Merkez / Company: Gümülsuyu Cad. Fazılpaşa Çıkması No: 13 Topkapı / İstanbul - Türkiye
Ofis / Office: Cumhuriyet Mah. Eski Hadımköy Yolu Cad. No:8 34500 Büyükçekmece / İstanbul - Türkiye
Fabrika / Factory: Vakıflar OSB Mah. Sanayi Caddesi NO:33/1 Ergene/TEK-RDA/